

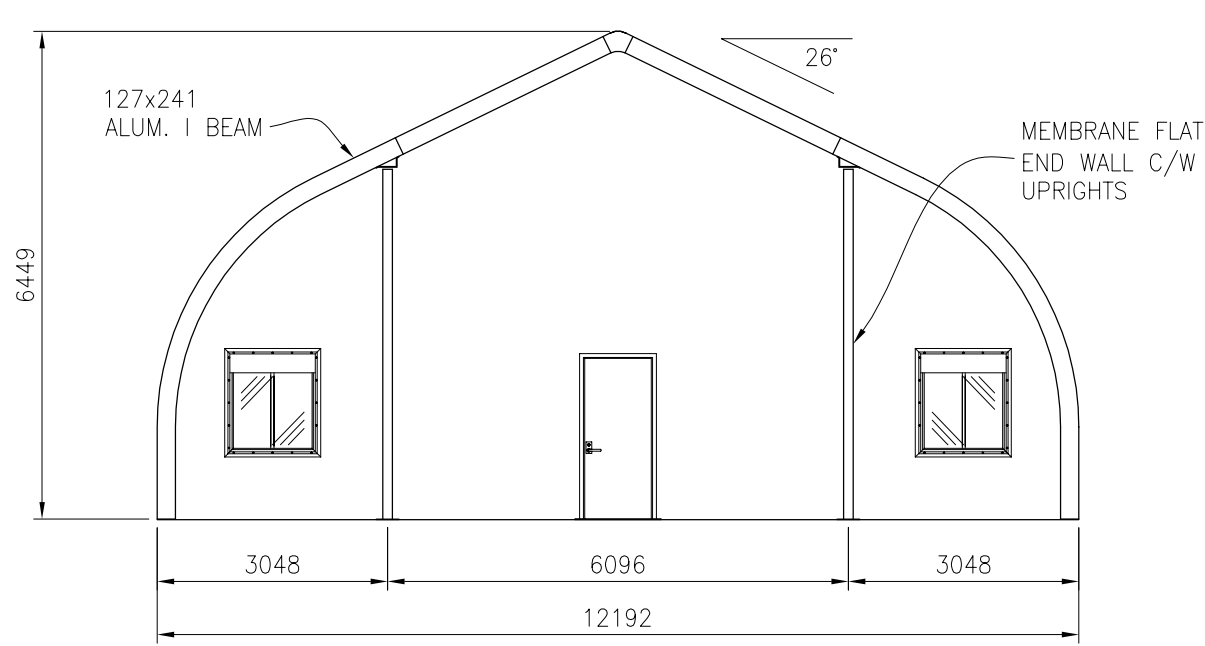

○ ELEVATION
1:125

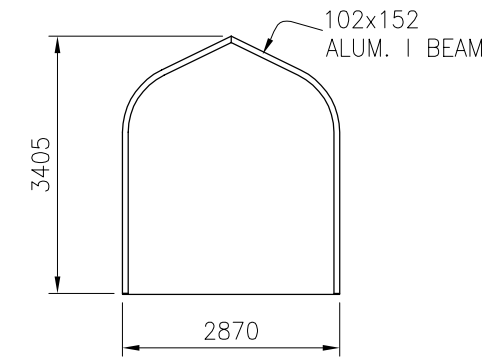

○ FLAT END 12.2m STRUCTURE
1:100



○ SECTION 2.9m HOOD
1:100

 SPRUNG INSTANT STRUCTURES [®] <small>Manufacturers of Engineered Relocatable Structures</small> TOLL FREE: 1-800-528-9899 OR (403) 245-3371 www.sprung.com	SODEXHO 12.2m x 18.3m STRUCTURE	
	<small>DATE</small> 04/16/2004	<small>SCALE</small> AS NOTED
	<small>DRAWING #</small> F04231B-R6	

SIGNATURE SERIES

3 PANELS @ 6096 = 18288

2.9m VESTIBULE
C/W 2 SINGLE
PERSONNEL DOORS

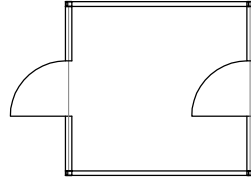

CABLE
BRACING

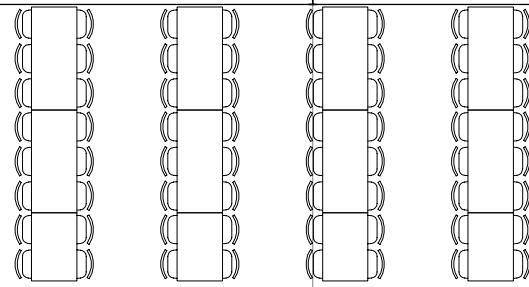

DINING AREA (128 SEATS)

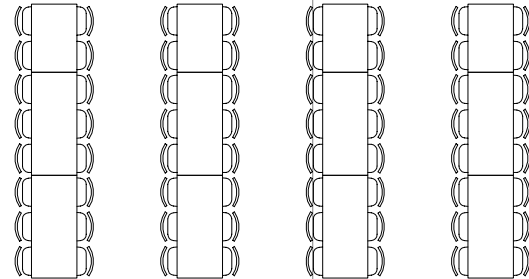

CABLE
BRACING

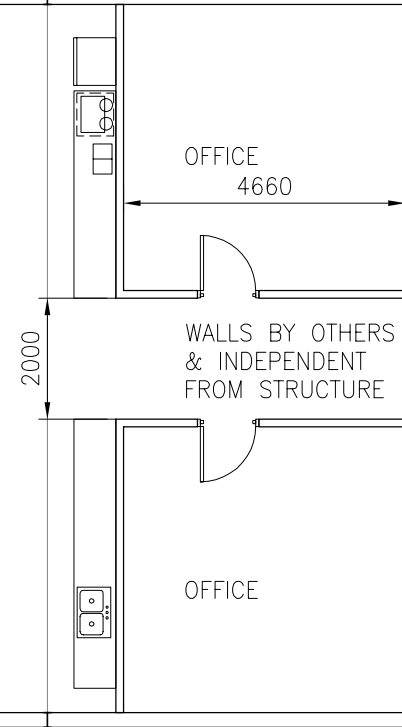

OFFICE
4660

WALLS BY OTHERS
& INDEPENDENT
FROM STRUCTURE

OFFICE

2000

991mm x
991mm
WINDOW C/W
SLIDER
2.9m VESTIBULE
C/W 2 SINGLE
PERSONNEL DOORS

991mm x
991mm
WINDOW C/W
SLIDER

12192

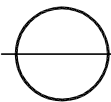

PLAN VIEW
1:125

INTERIOR SHOWN FOR
REFERENCE ONLY, FINAL
LAYOUT DESIGNED &
SUPPLIED BY OTHERS.

SIGNATURE SERIES



SPRUNG

INSTANT STRUCTURES®

Manufacturers of Engineered Relocatable Structures

TOLL FREE: 1-800-528-9899
OR (403) 245-3371 www.sprung.com

SODEXHO

12.2m x 18.3m
LUNCH ROOM

DATE
04/16/2004

SCALE
AS NOTED

DRAWING #

F04231A-R6